

Frånluftsdon BYBA

TEKNISKA DATA





FRÅNLUFTSDON BYBA

Frånluftsdon BYBA är avsett att användas i villor och lägenheter med mekaniskt ventilationssystem. Donen kan placeras i vägg eller tak.

SNABBVAL

Don	Luftflöde l/s (m ³ /h) vid ljudnivå		
	20 dB(A)	25 dB(A)	30 dB(A)
BYBA	17	22 (79)	24



SPECIFIKATIONER

- Låg ljudnivå
- Kan monteras utan ram
- Lätt att injustera
- Lätt att rengöra

PRODUKTKOD EXEMPEL

Frånluftsdon BYBA-4-010

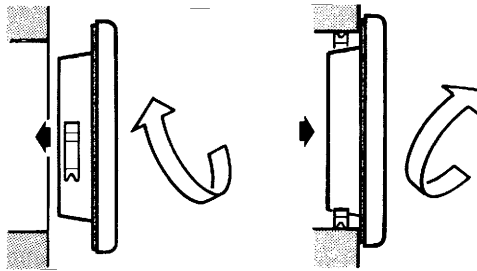
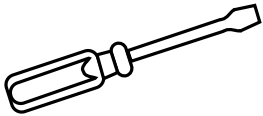
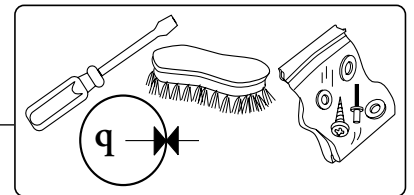

BYBA

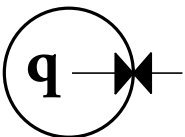
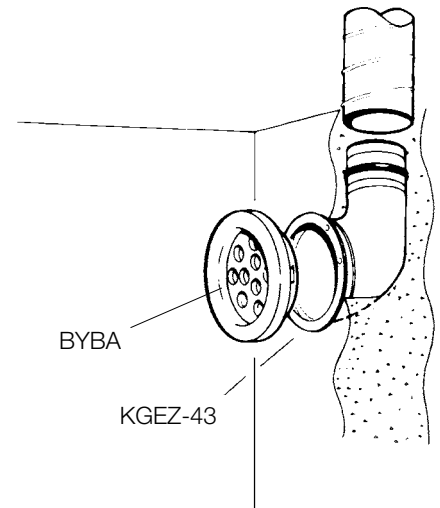
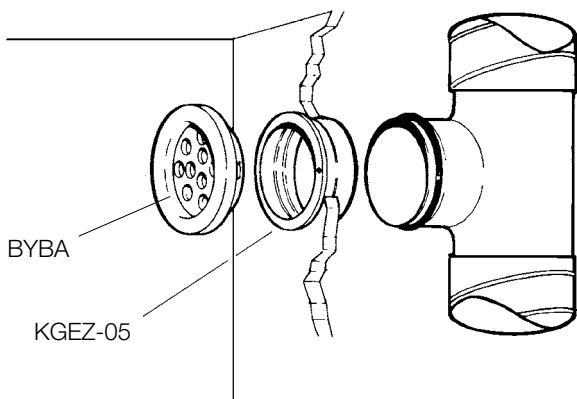
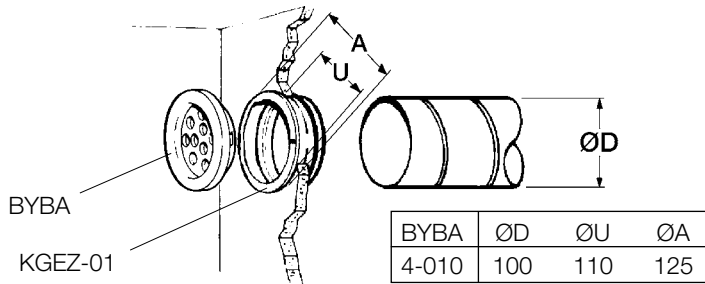

$$q = k \sqrt{\Delta p_m}$$

(l/s) (Pa)

$$q = 3.6k \sqrt{\Delta p_m}$$

(m³/h) (Pa)

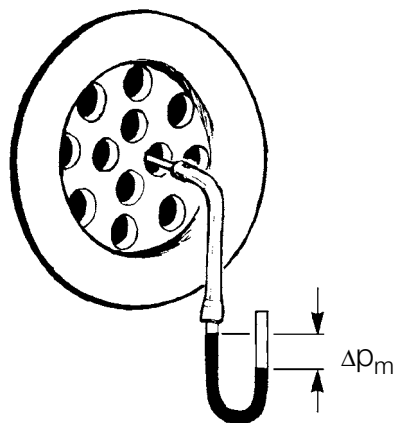

	k2
1	0.24
2	0.42
3	0.59
4	0.80
5	0.98
6	1.2
7	1.5
8	1.6
9	1.8
10	2.1
11	2.3
12	2.5

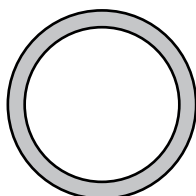
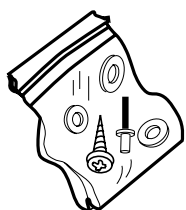
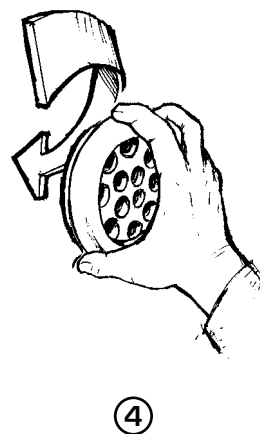
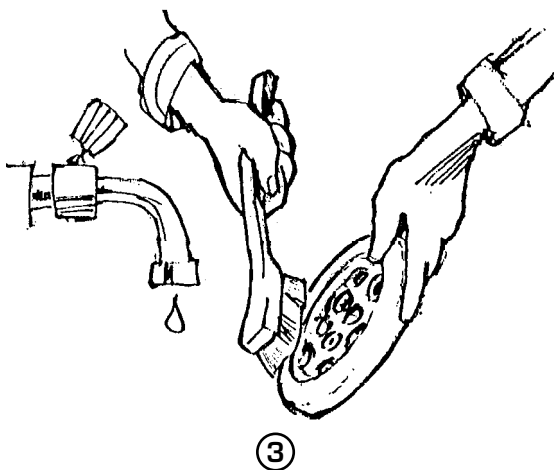
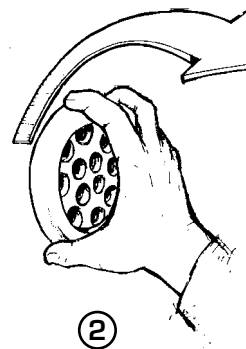
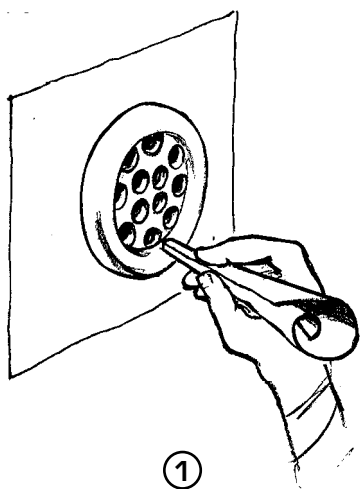
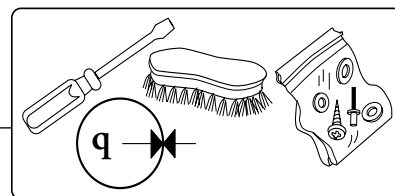

BYBA-4-010

ØD
100

BYBA-99-01